

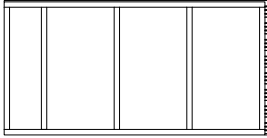

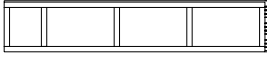

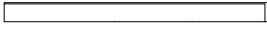

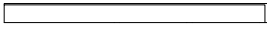

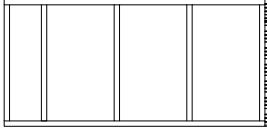

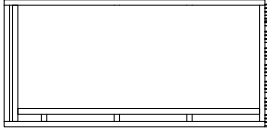
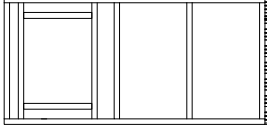
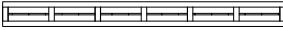
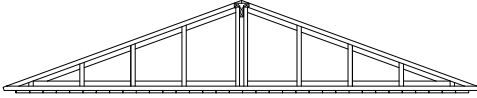
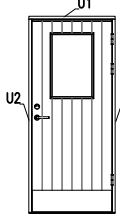
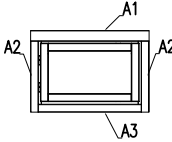
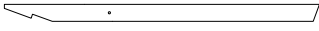

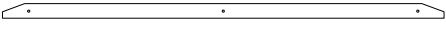



















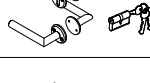

EL1		2155 x 1097 x 160	9
EL2		2155 x 417 x 160	4
EL3		2155 x 169 x 65	2
EL4		2155 x 160 x 74	2
EL5		2155 x 1019 x 160	1
EL6		2155 x 1027 x 160	1
EL7		2155 x 1097 x 160	1
EL8		2155 x 1097 x 160	2
EL9		2310 x 202 x 160	1
EL10		4903 x 988 x 160	2
U105-21-920R	 <p>U1 - 19x45x980 2 pcs U2 - 19x70x1980 4 pcs</p>	870 x 1985 x 105	1
A105-8R	 <p>A1 - 19x70x830 2 pcs A2 - 19x70x1050 4 pcs A3 - 19x70x630 2 pcs</p>	785 x 475 x 105	2
101		45 x 195 x 2610	18
102		45 x 195 x 551	9
103		28 x 120 x 3834	18

1		Impregnated	45 x 95 x 5165	2
2		Impregnated	45 x 95 x 4348	1
3		Impregnated	45 x 95 x 1047	2
4			44 x 95 x 5198	2
5			19 x 89 x 3559	64
6			19 x 89 x 2359	64
7			32 x 40 x 2594	4
8			16 x 120 x 2669	8
9			19 x 70 x 2676	4
10			16 x 120 x 2959	4
11			28 x 160 x 1928	2
12			28 x 160 x 2254	1
13			19 x 120 x 2394	1
14			19 x 70 x 1925	2
15			19 x 70 x 2200	4
F1			70 x 70 x 55	18
F2			Ø 6 x 120	8
F3			Ø 5 x 90	230
F4			Ø 4.5 x 50	320
F5			Ø 4 x 40	480
F6			Ø 2,2 x 50	720
F7			QULink/ASSA QULSydamik/ASSA QULSydamikkate/ASSA	1 set
F8		QKR4_5x25Zn	Ø 4.5 x 25	8
F9		QTU	130x147toruga	2
F10		QNP100x240Zn	100 x 240 x 2	18
F11		QPOKK12x120Zn	M12 x 120	27
F12		QMUKK12Zn	M12	27
F13		SE12x35Zn	12 x 35	54
F14		QKRPP4_5x70ZnTX	Ø 4.5 x 70	720



1

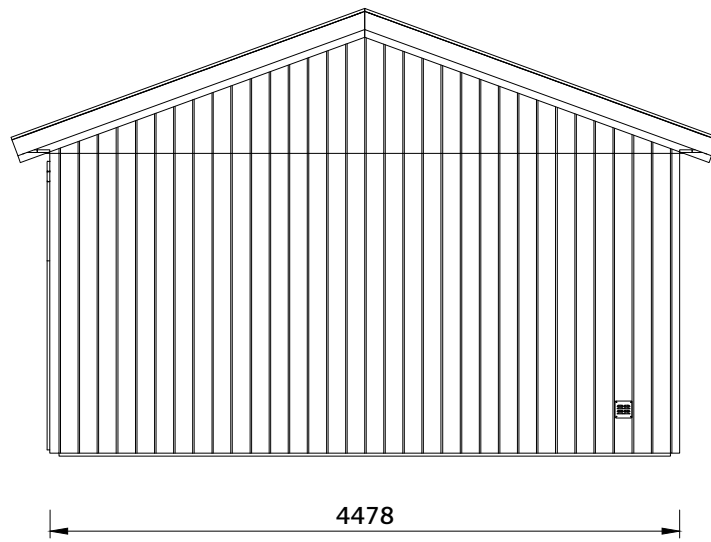
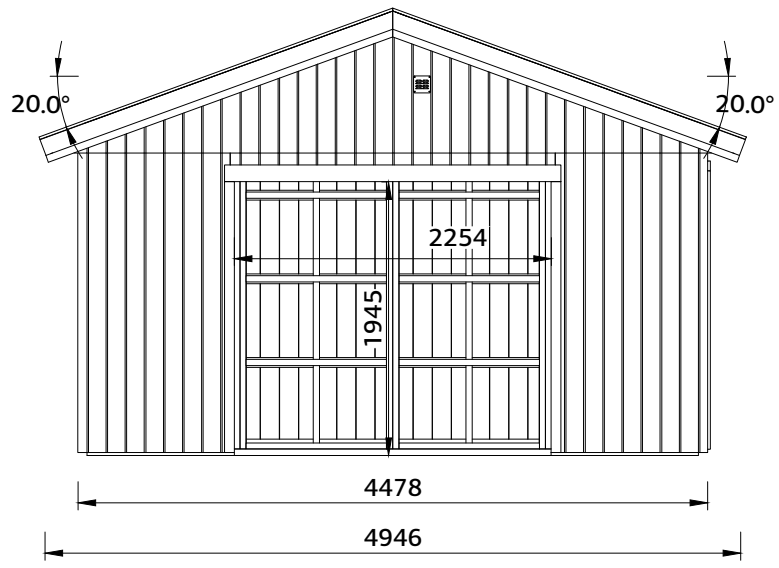
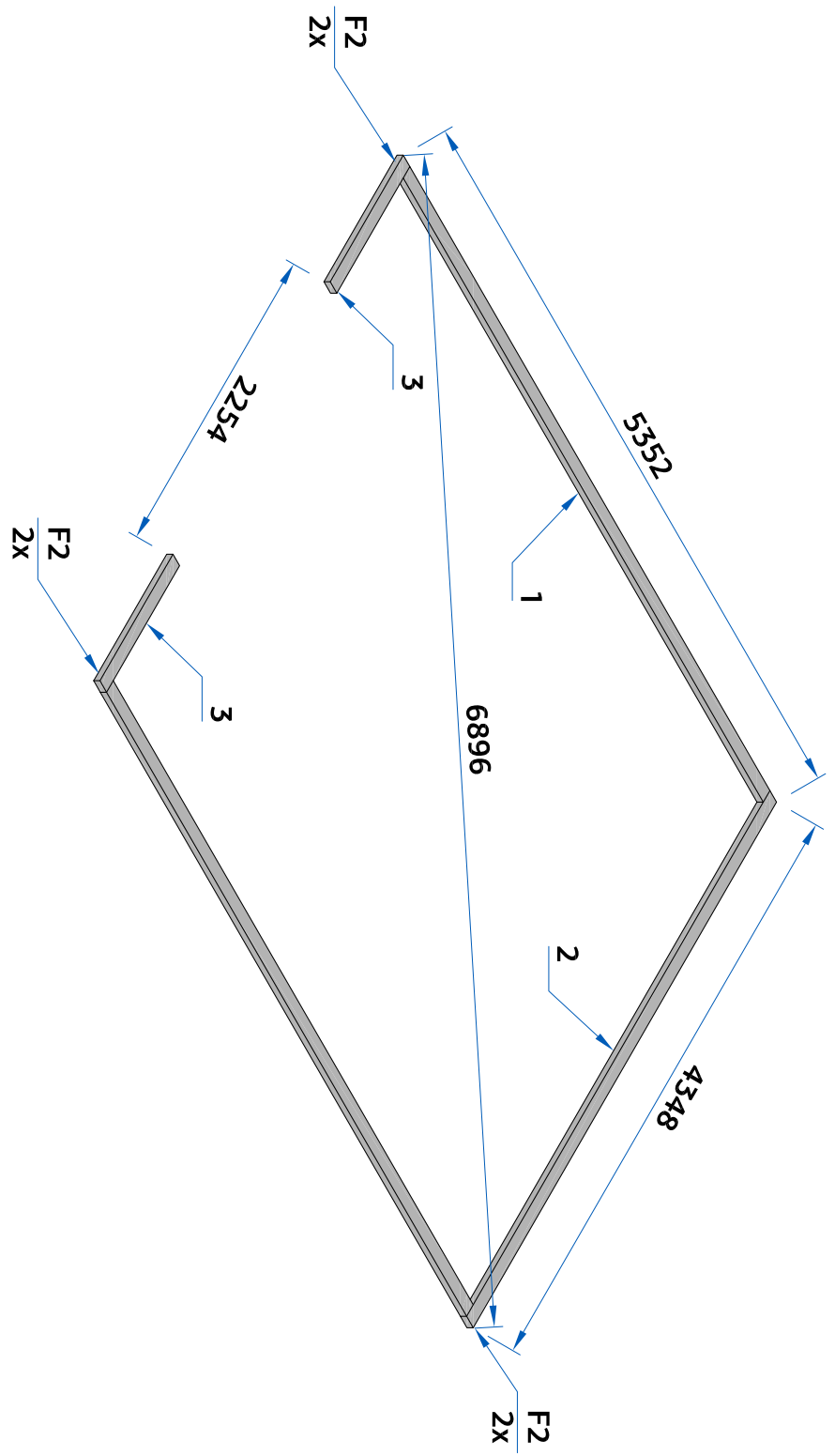

2

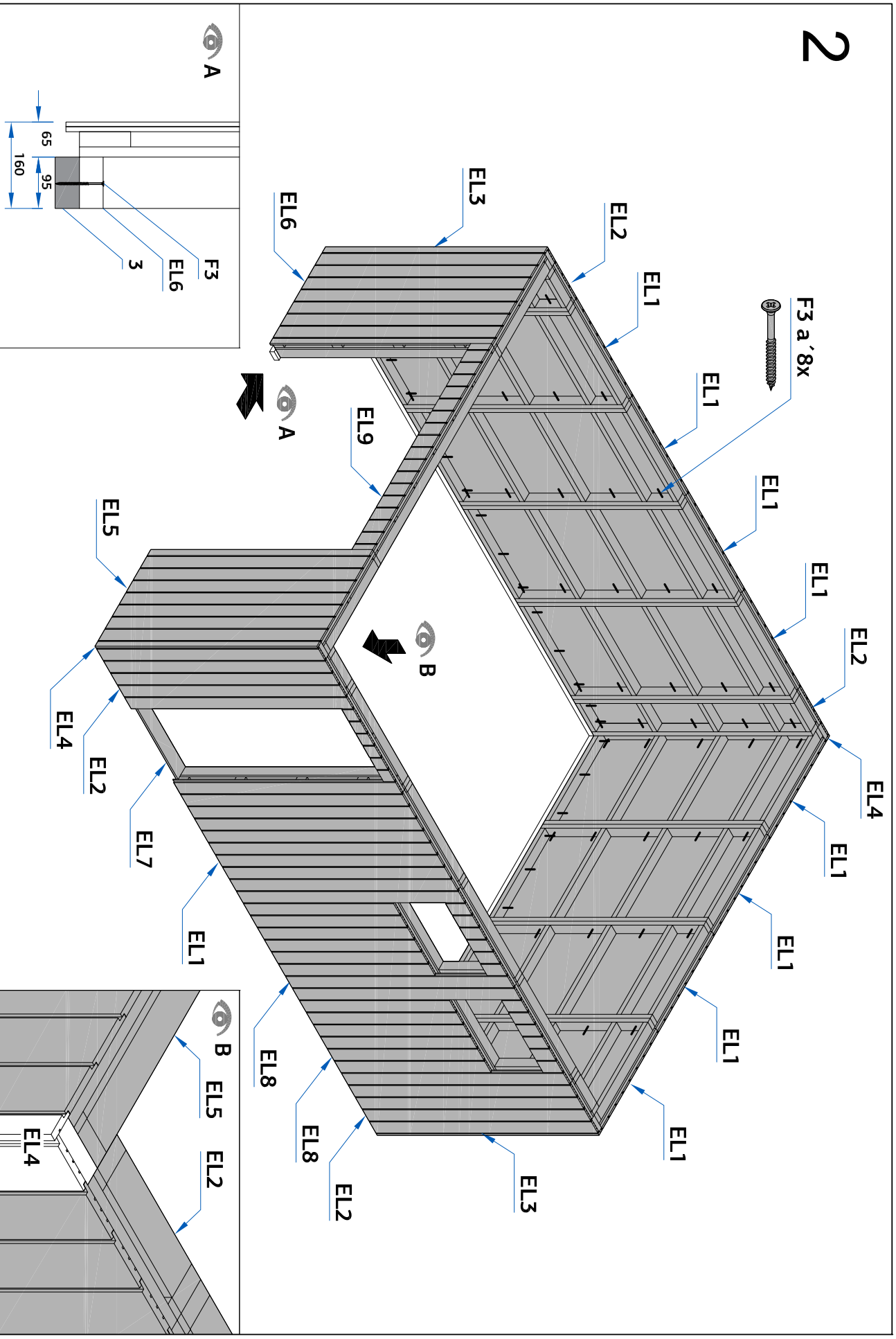

A



B



A



B

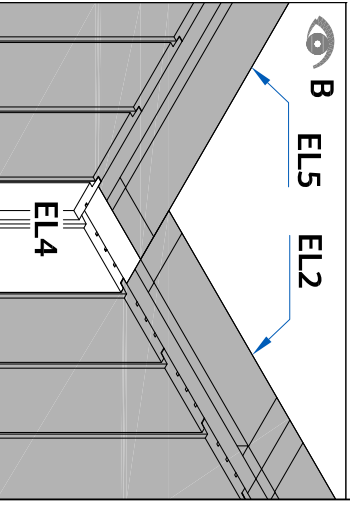
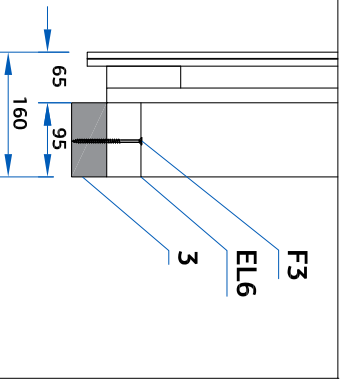

3

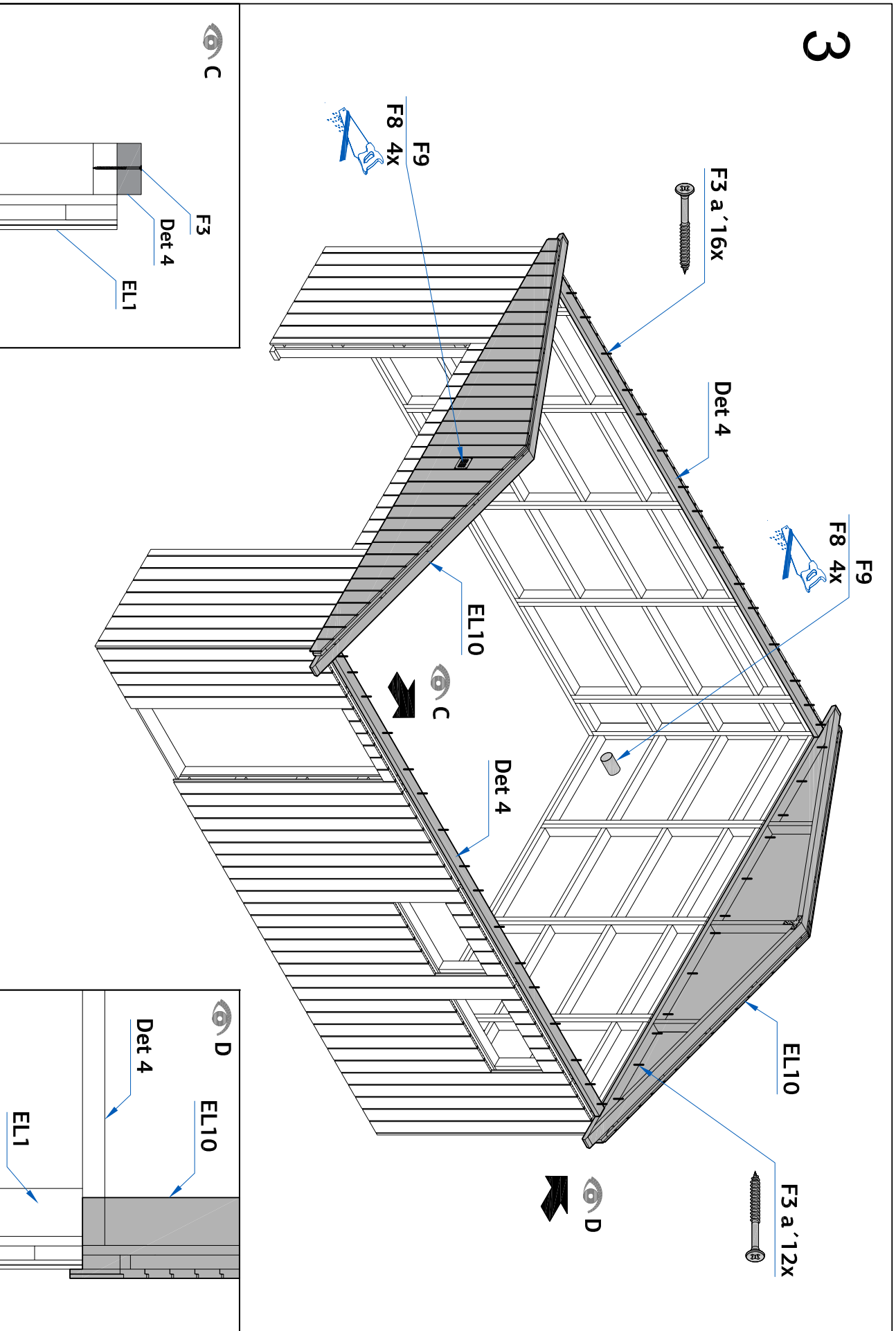

# 4

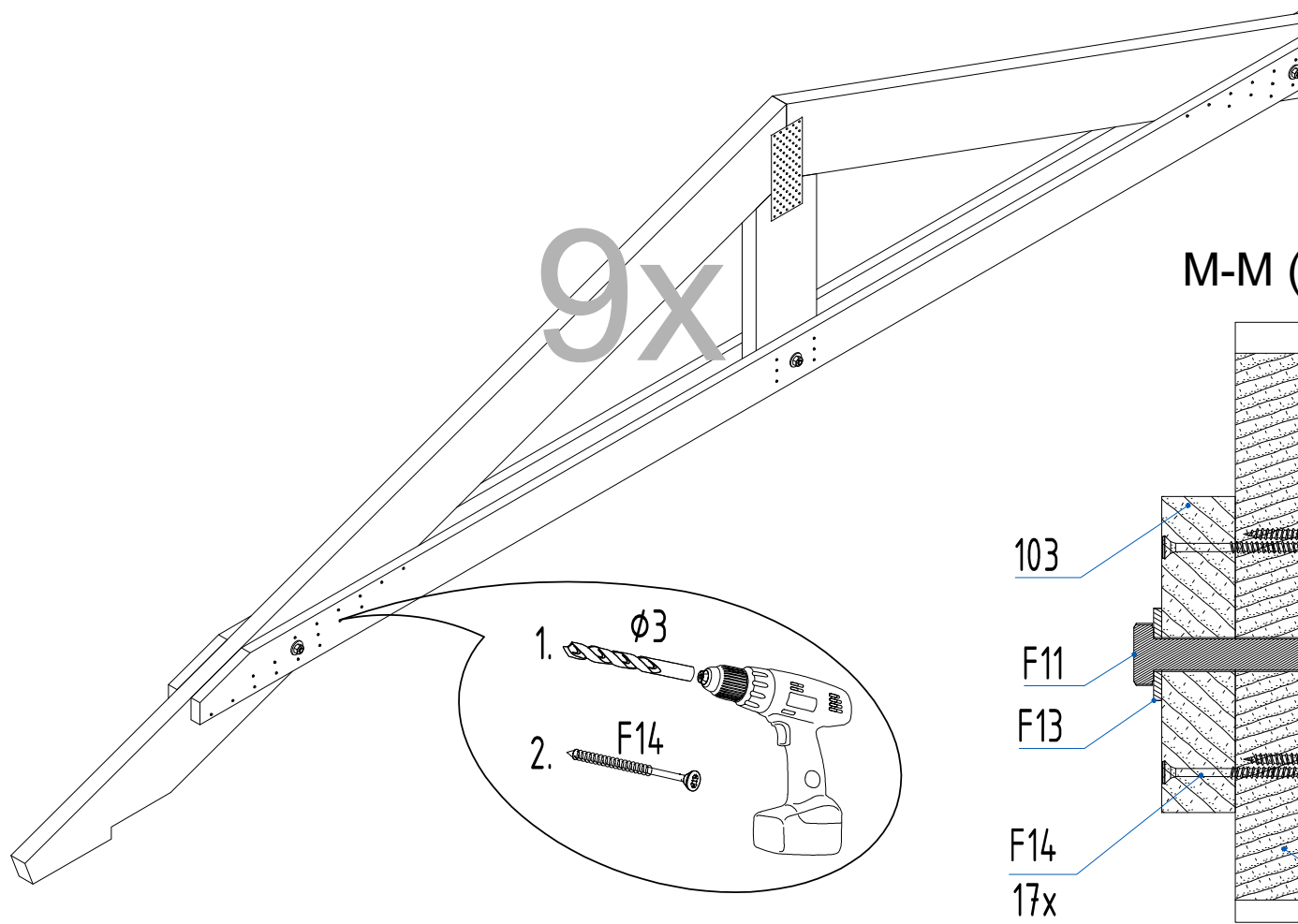
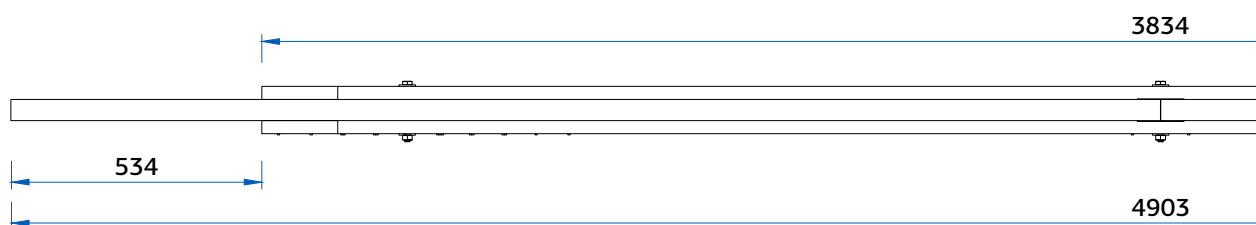
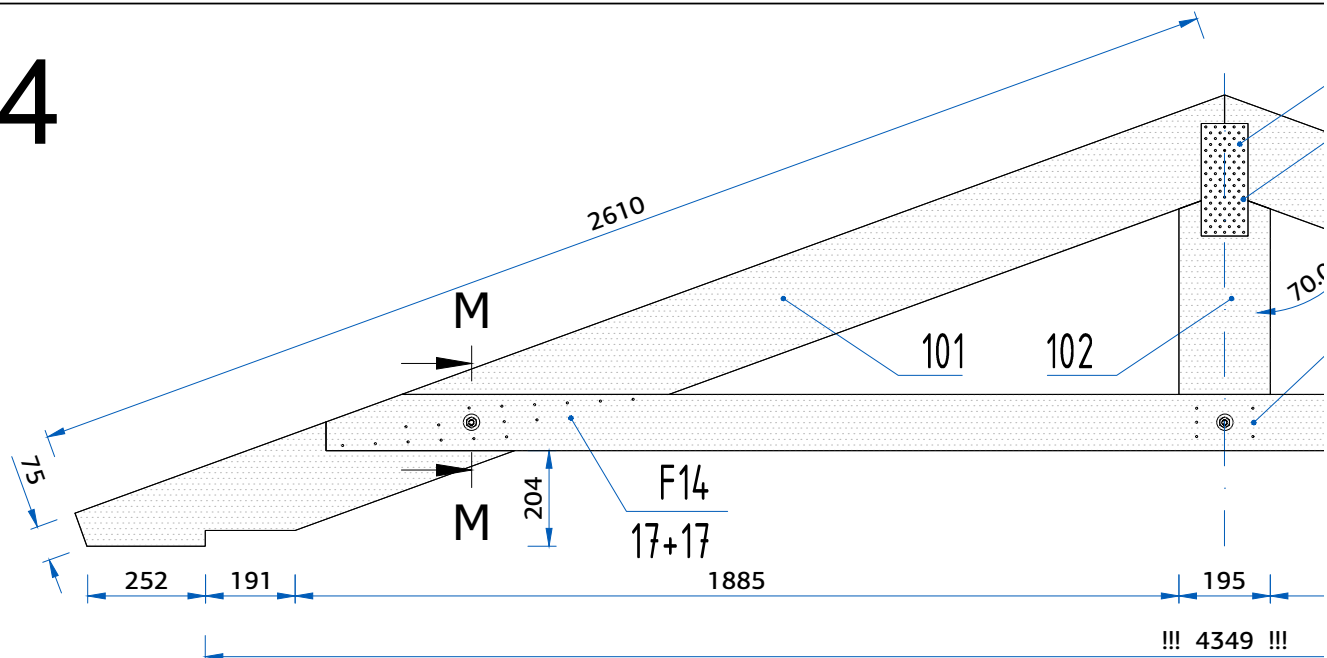

5

E

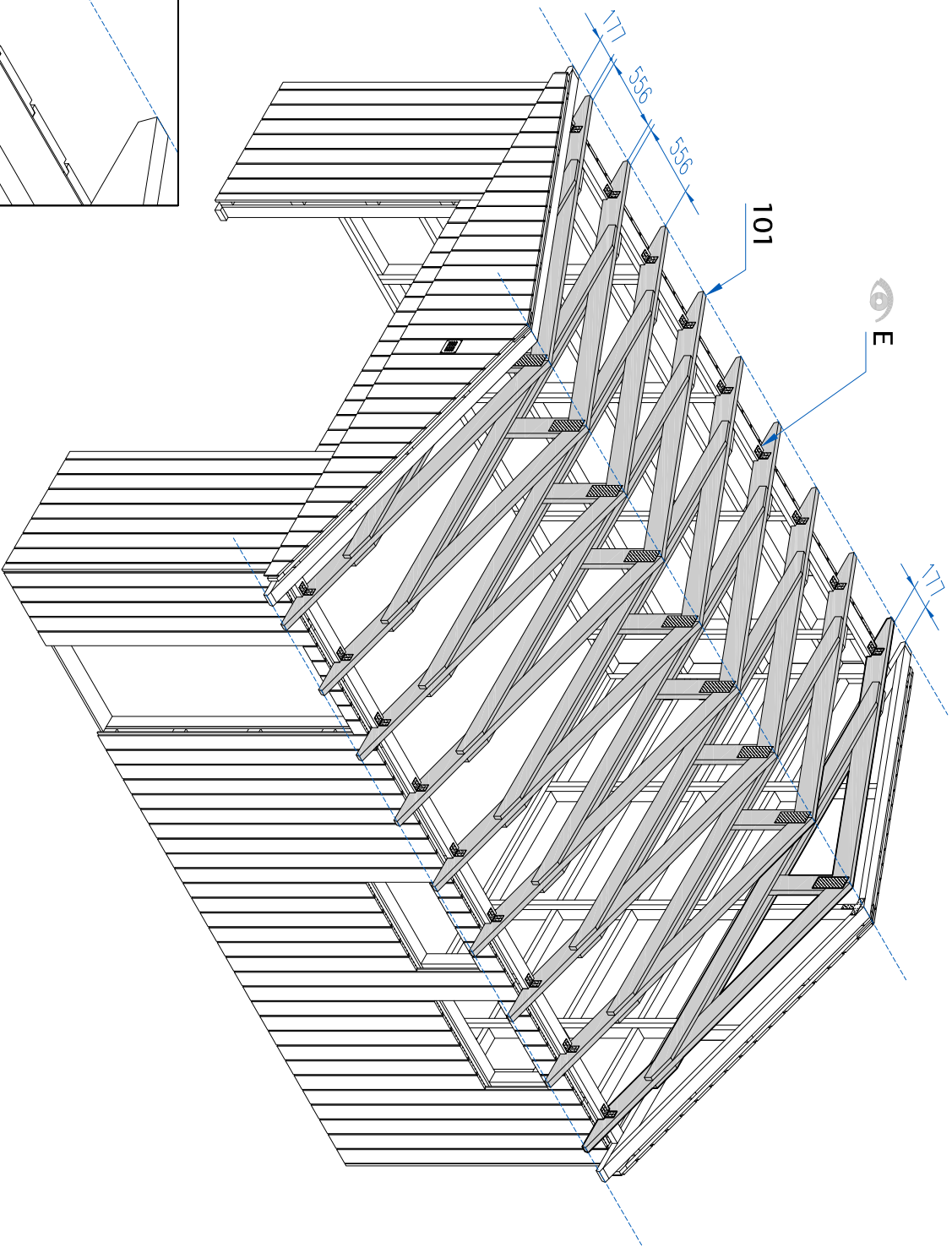

E

F1+

F5 a'12x

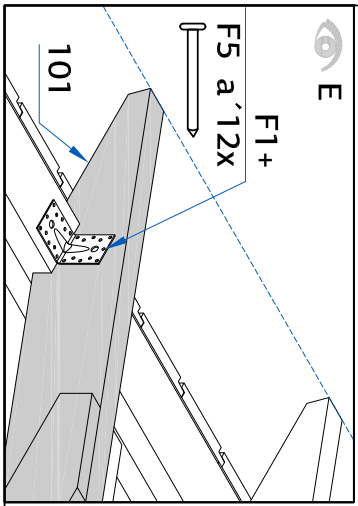



# 6

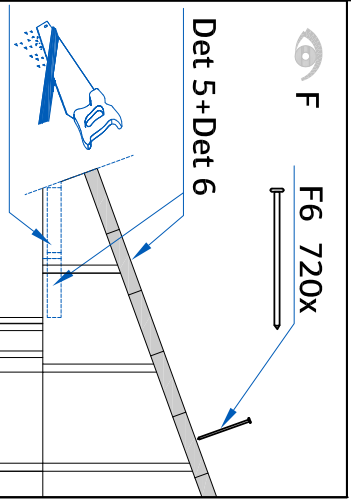
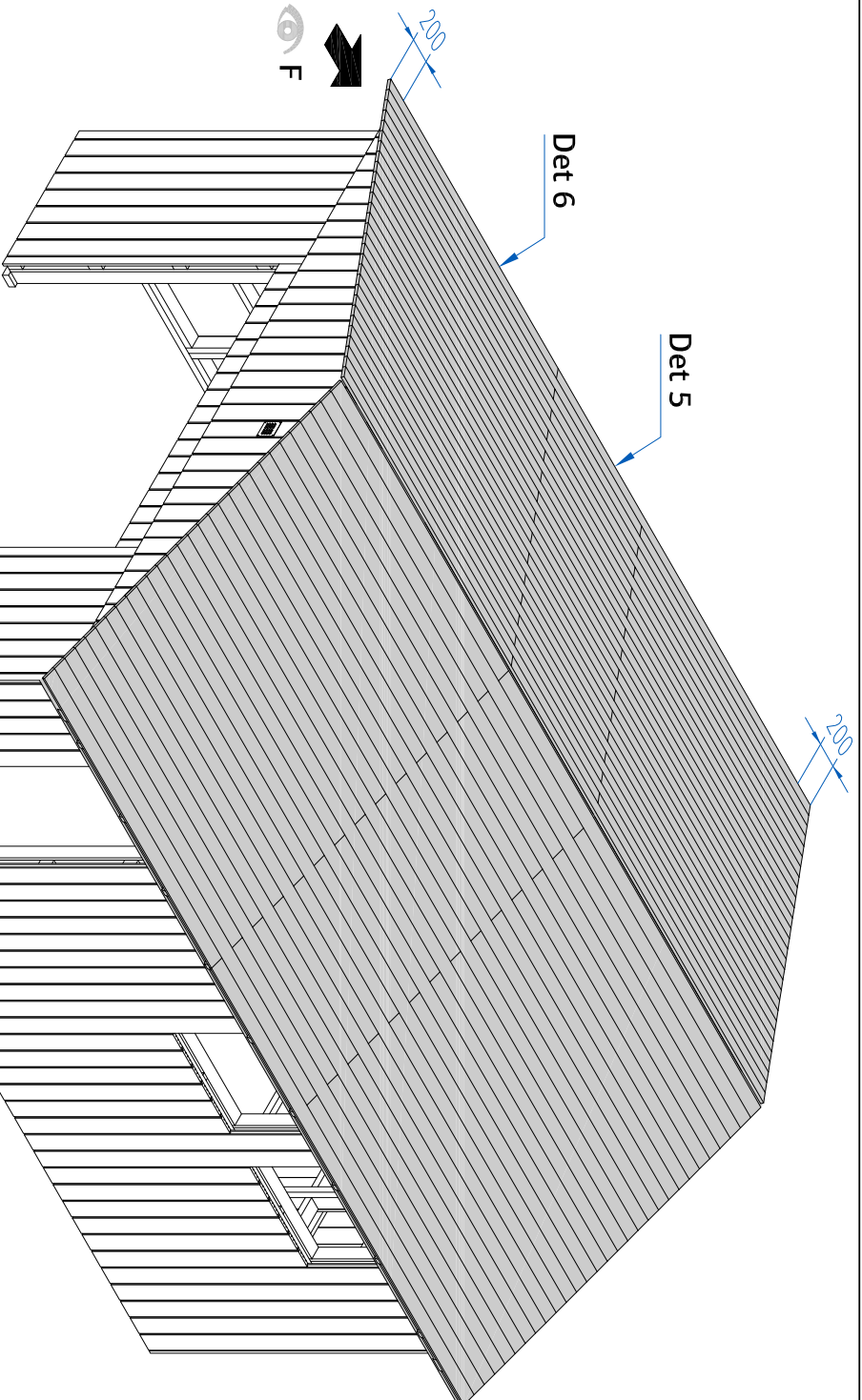

7

