

1/170/23

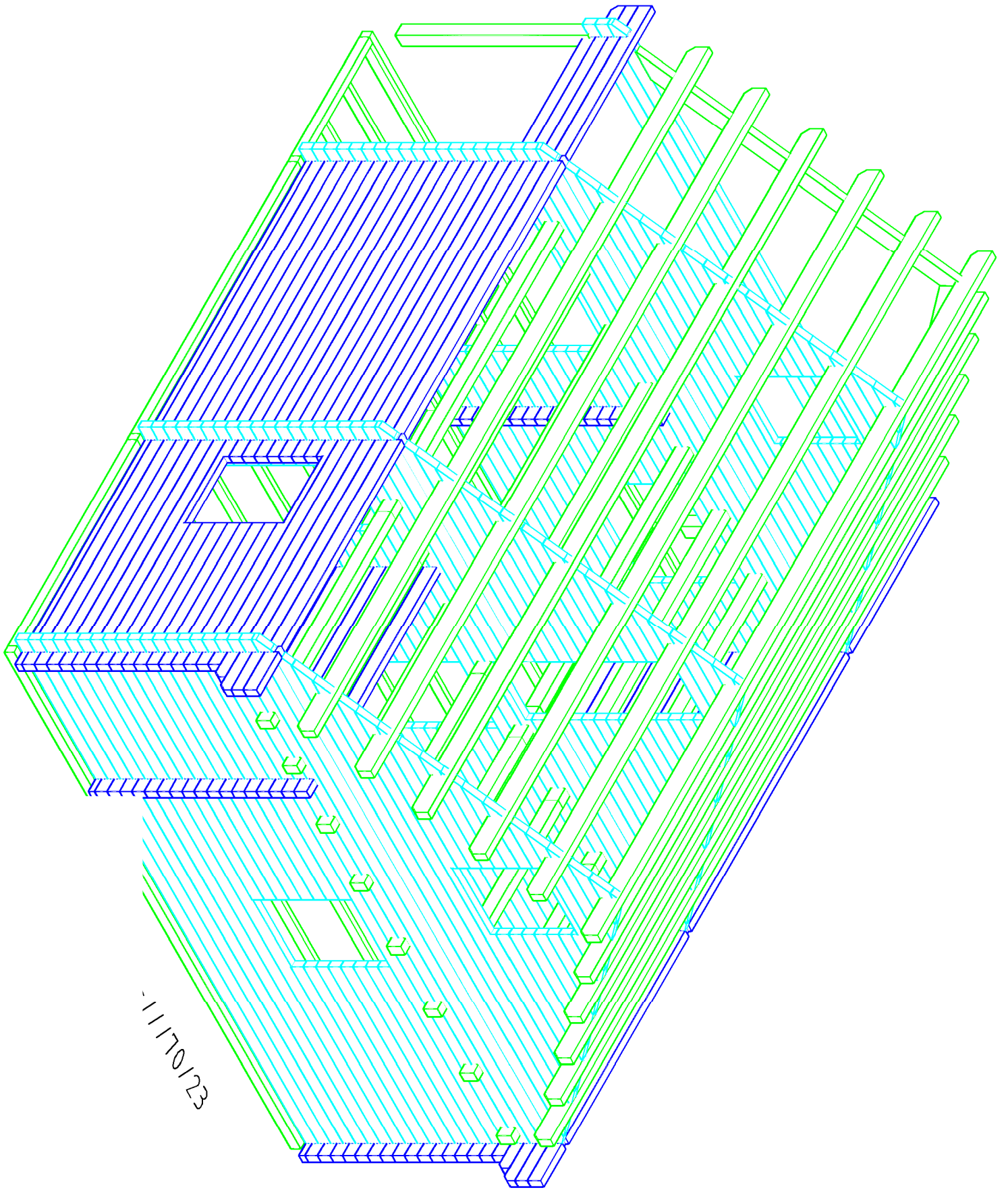

11/170/23

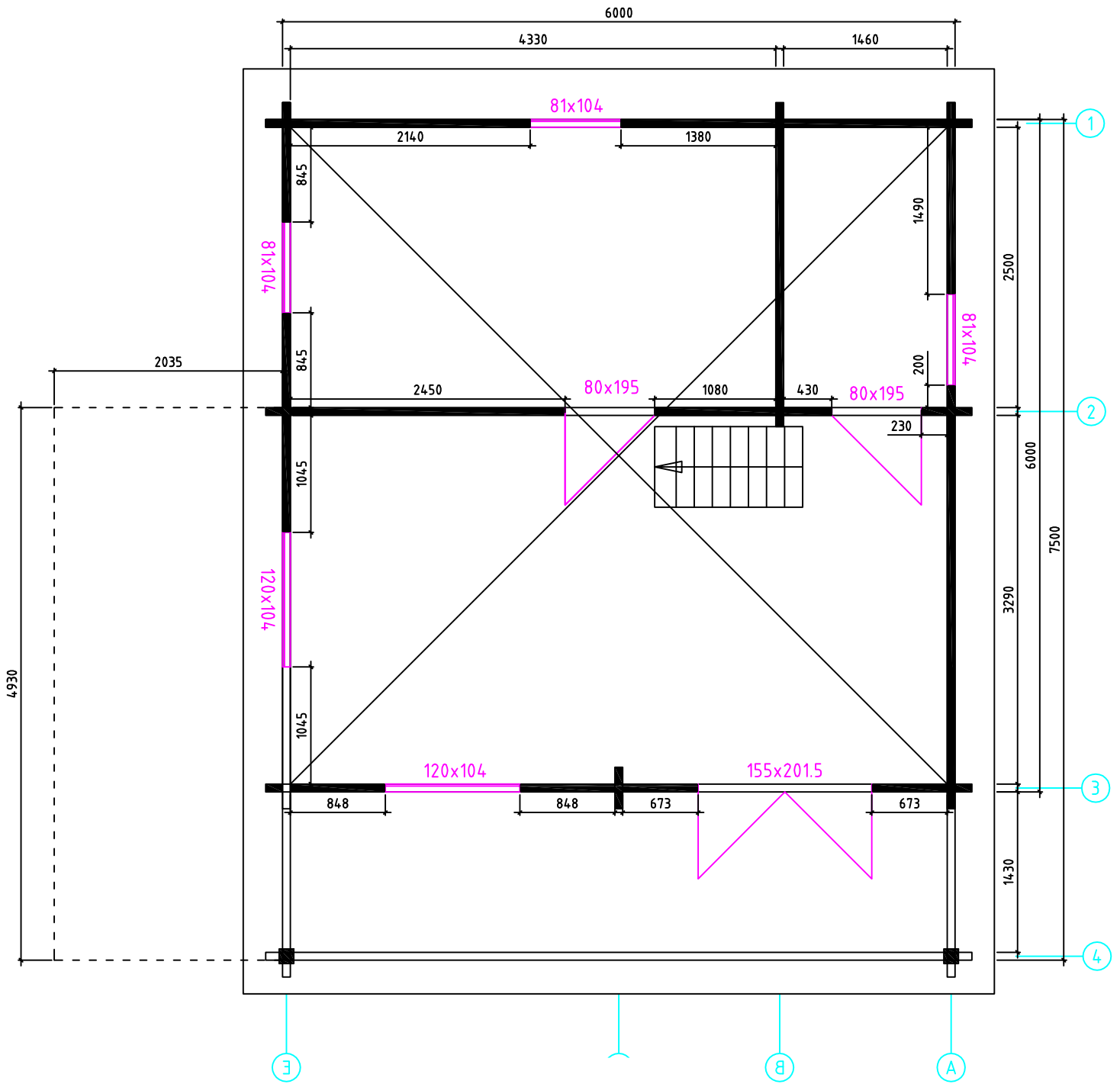

///70/23

Grundplan

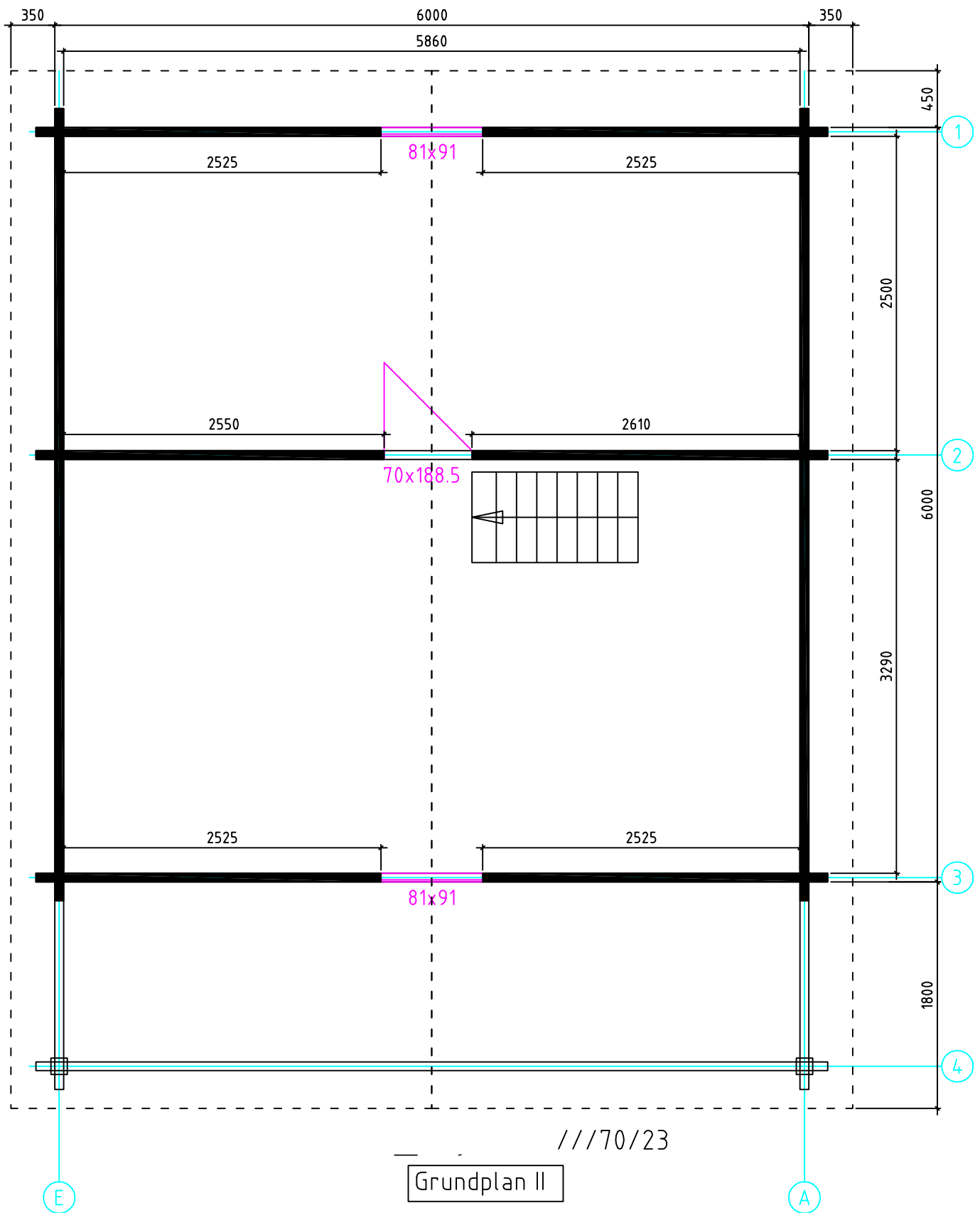

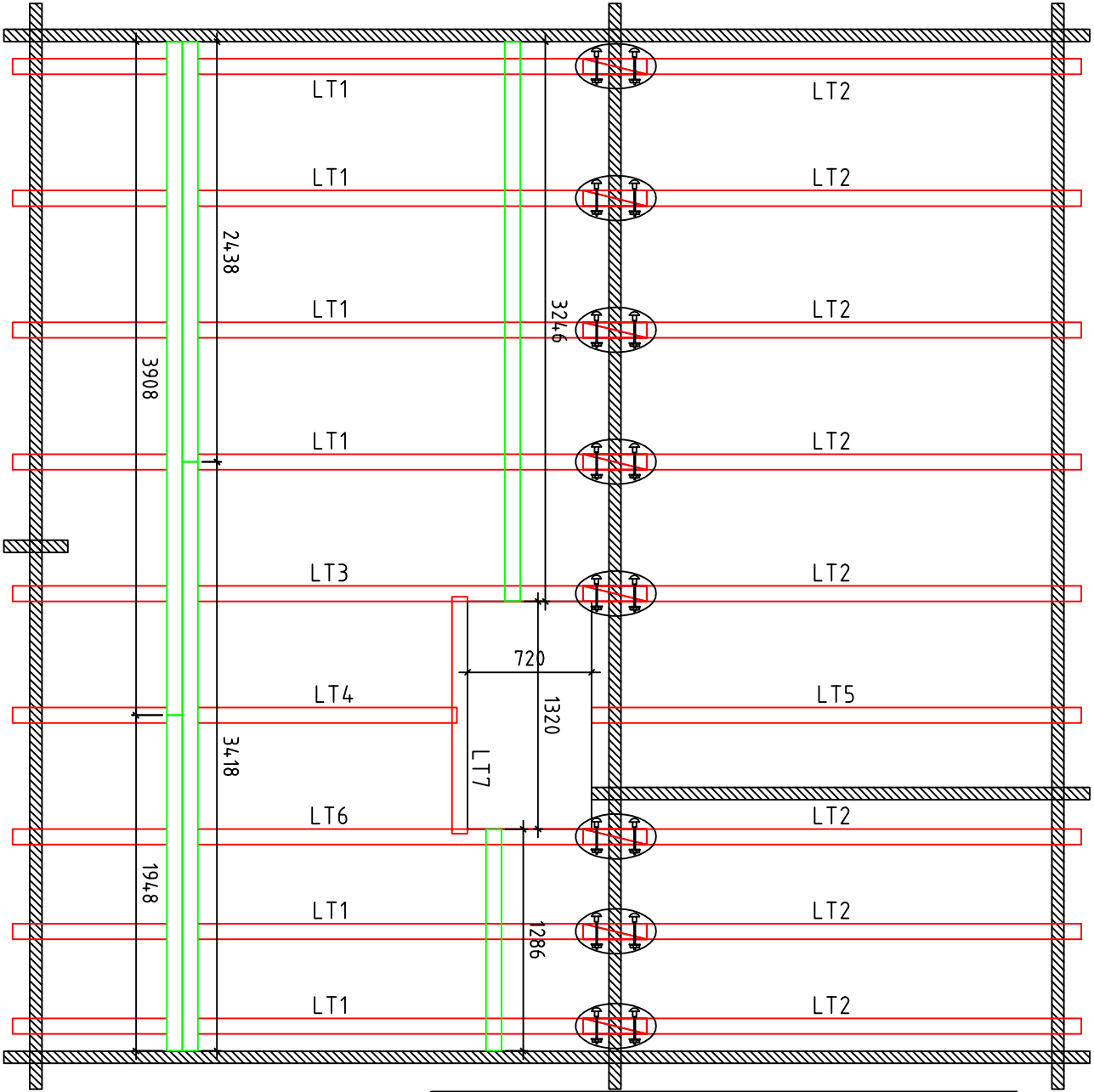

1/170/23

Deckenbalken

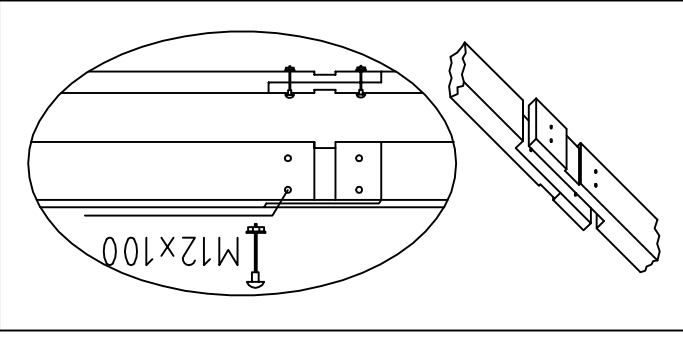

///70/23

Dachbalken

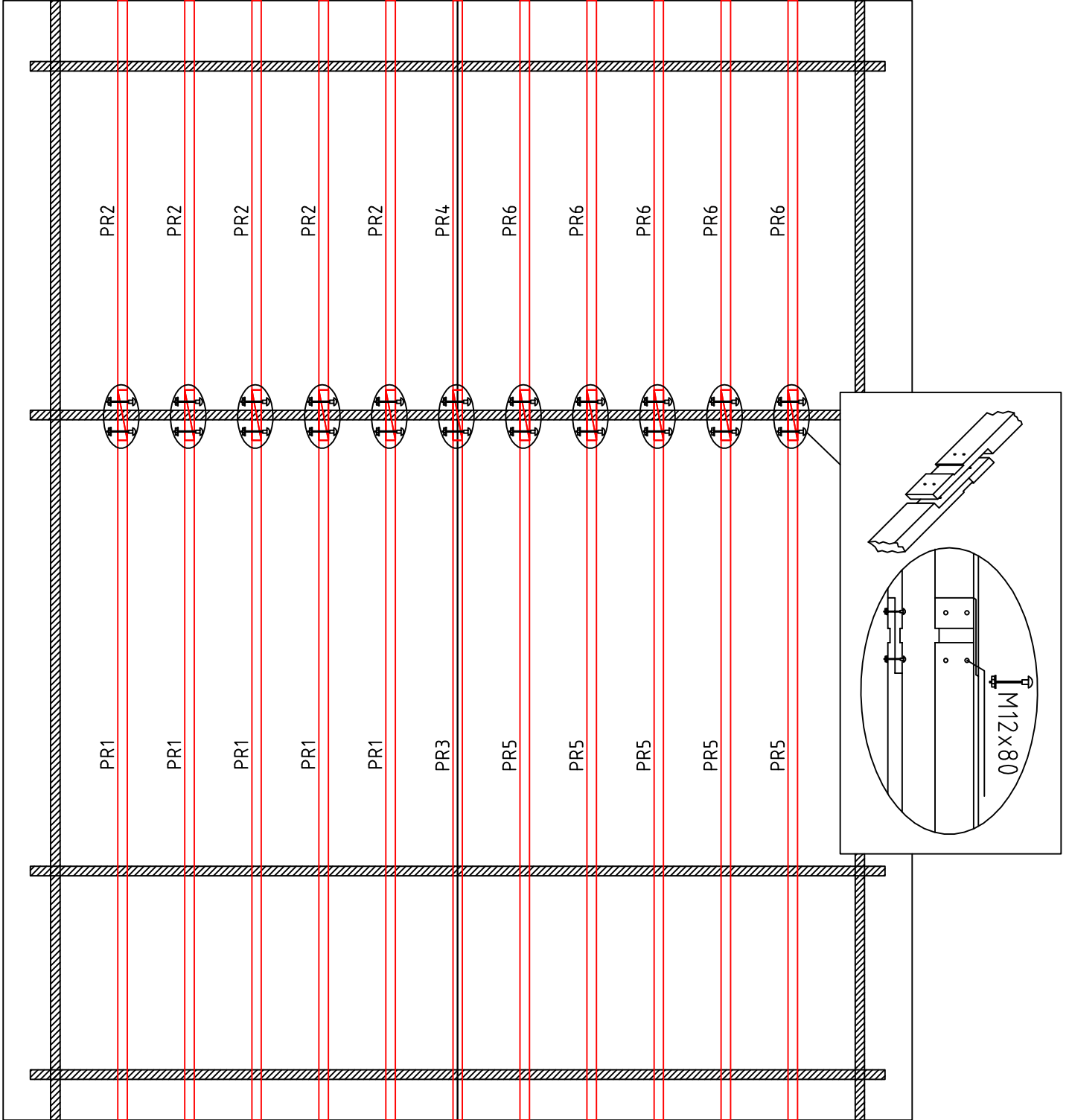

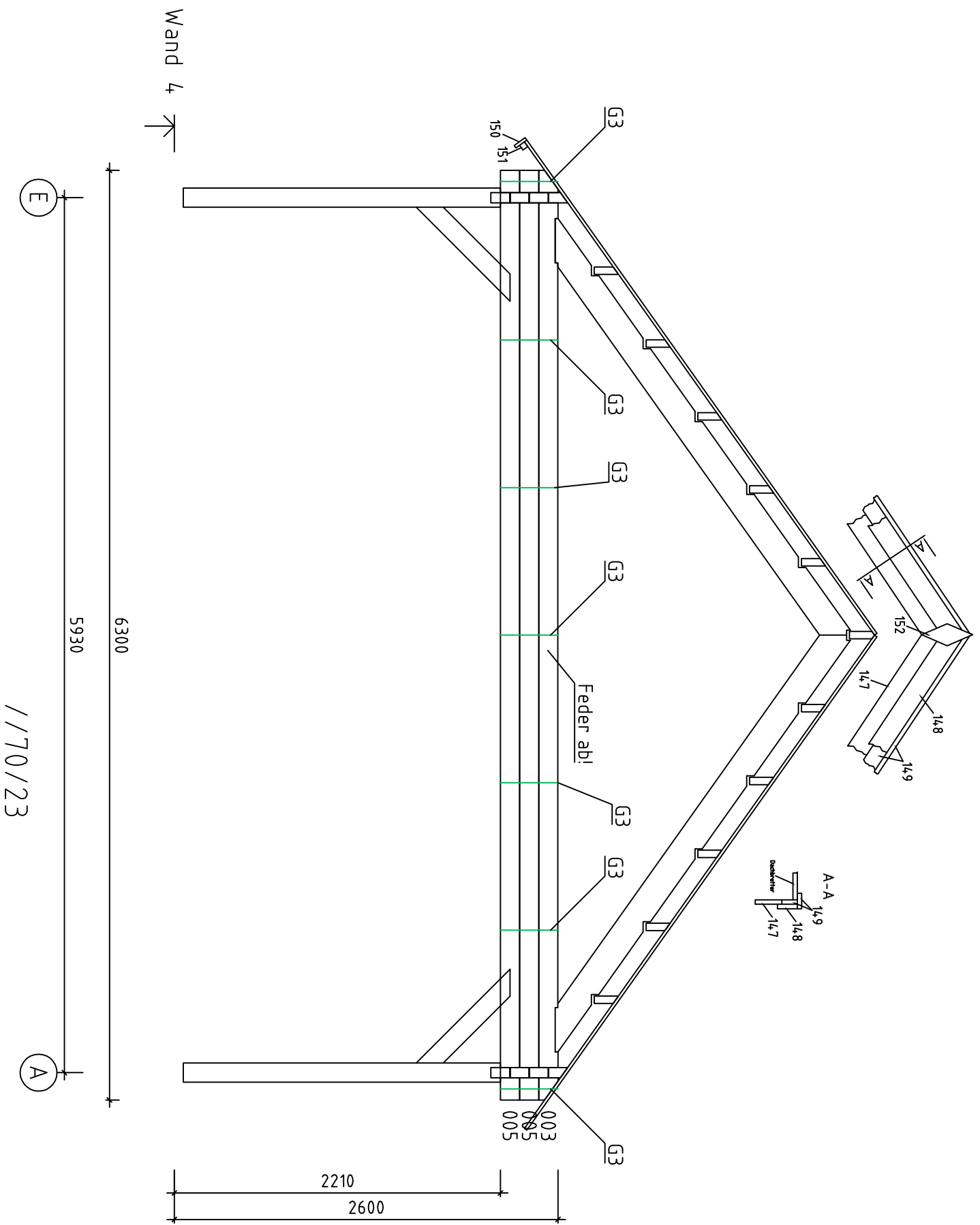



/ / 70 / 23

⊙ E

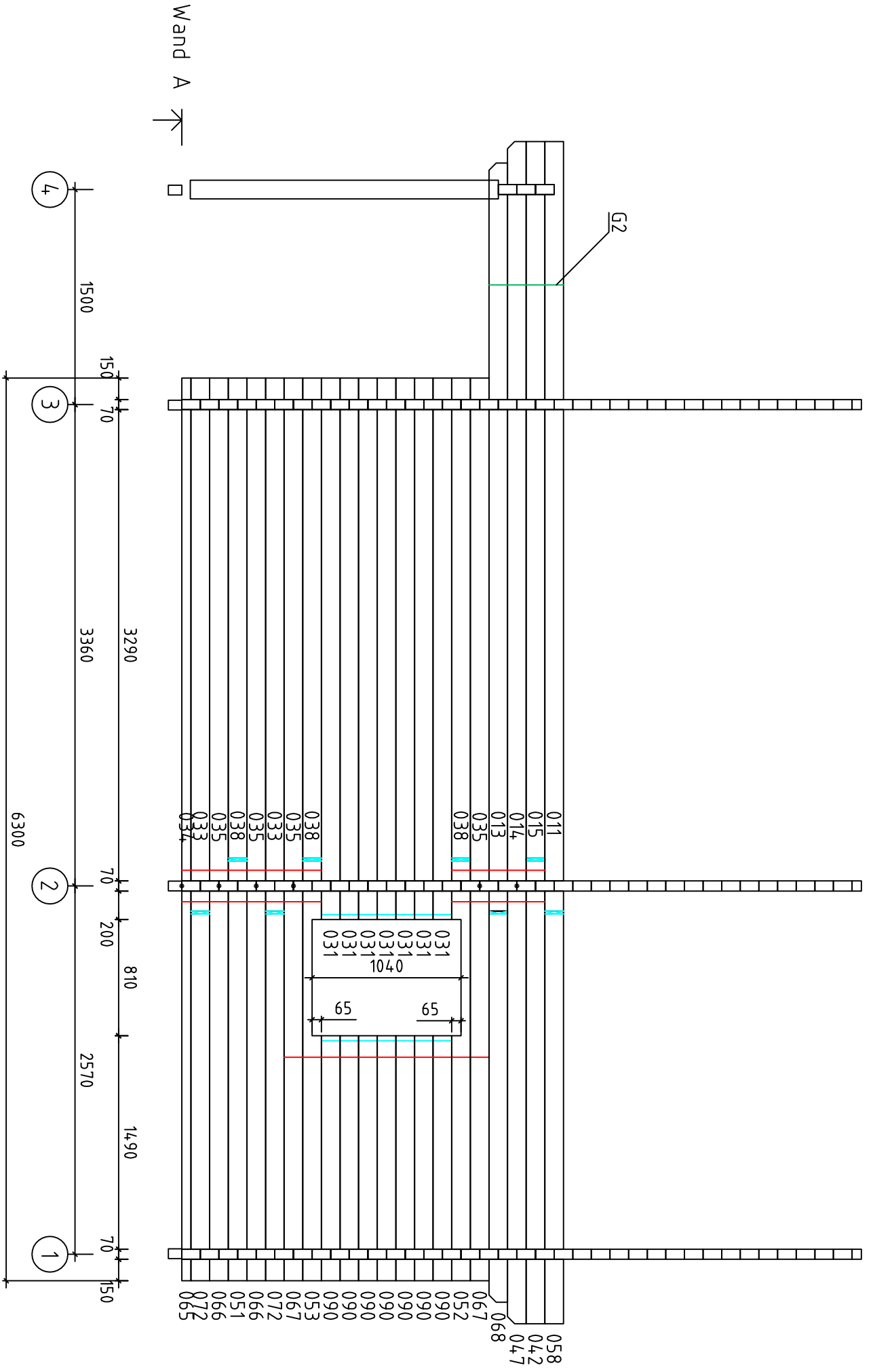
⊙ A



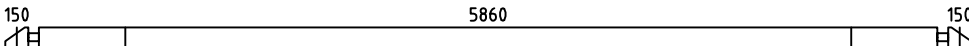
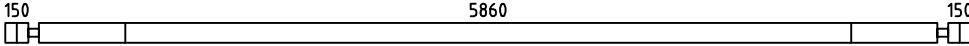
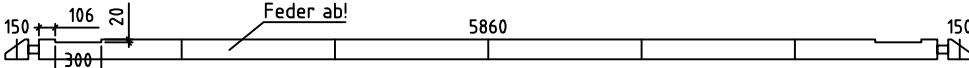
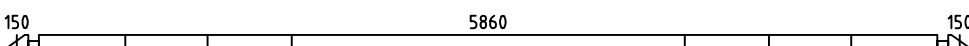
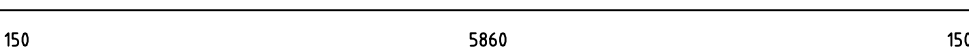
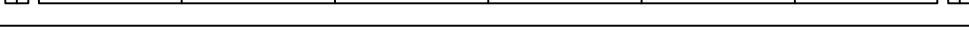
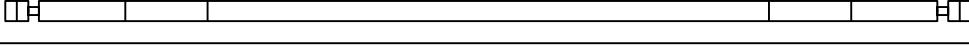
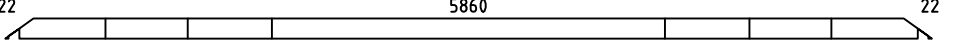
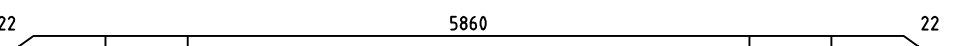

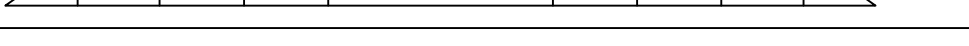
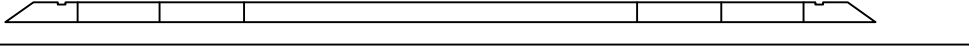
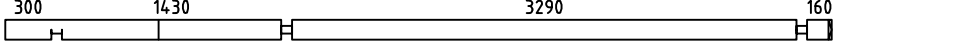
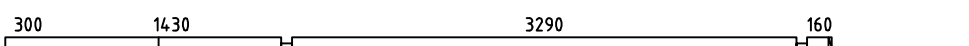
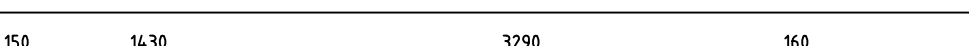
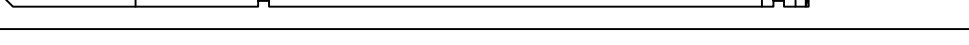
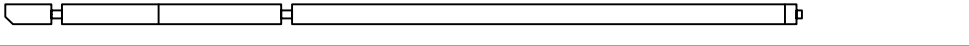
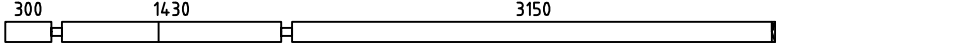
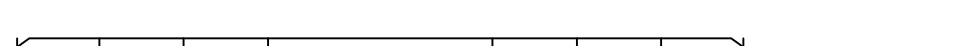
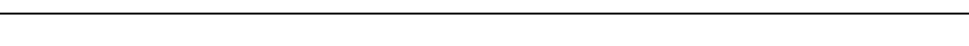
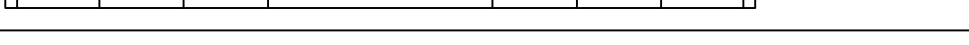
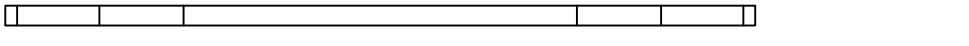
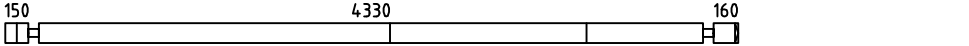
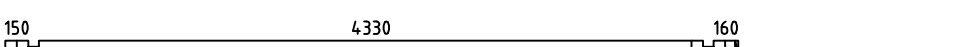
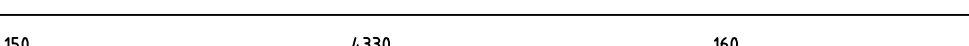

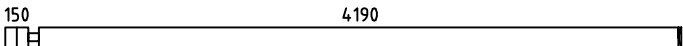
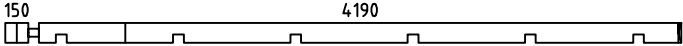
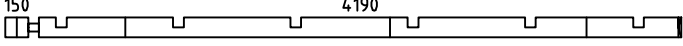
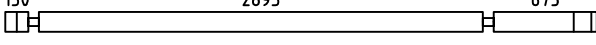
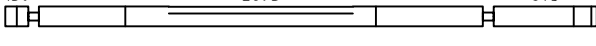
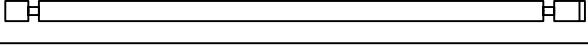
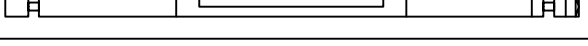
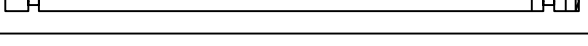
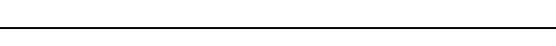
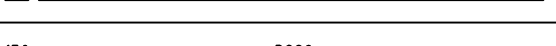
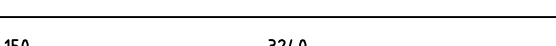
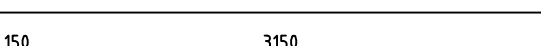
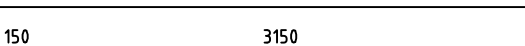
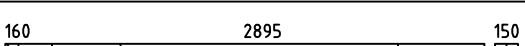
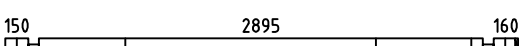
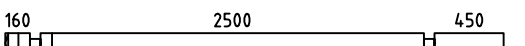
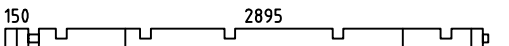
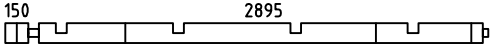
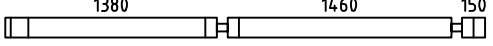
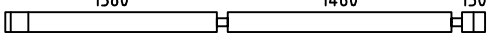
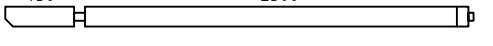
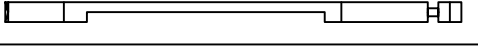
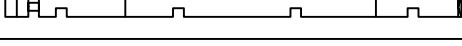
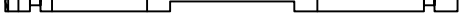
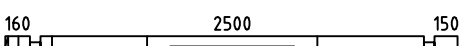

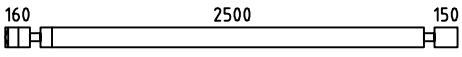
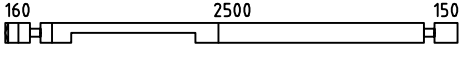
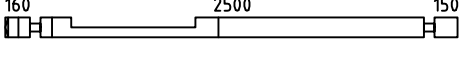
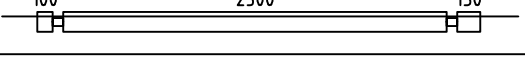
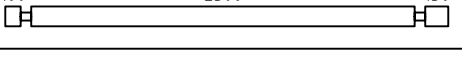
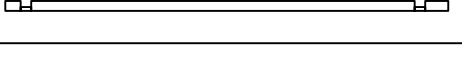
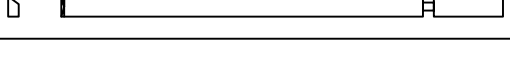
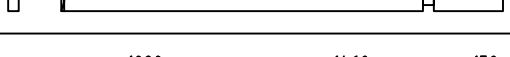
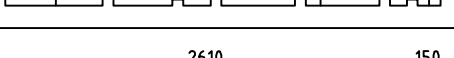
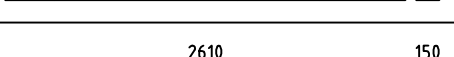
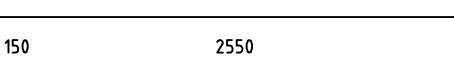
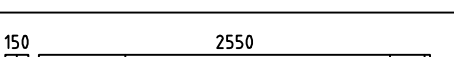
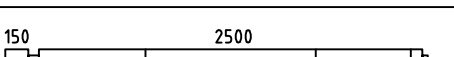
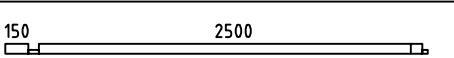
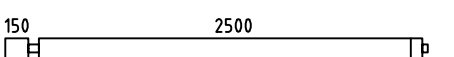
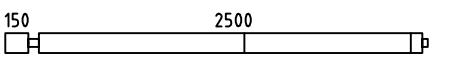
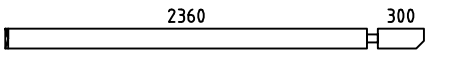
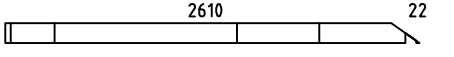
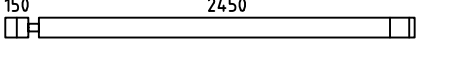
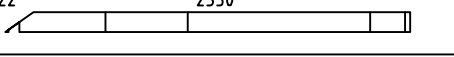
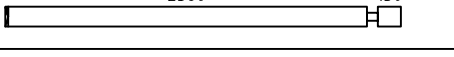
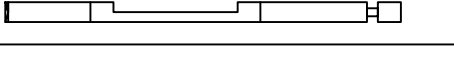
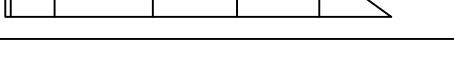
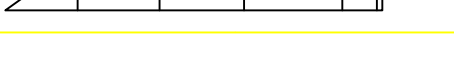

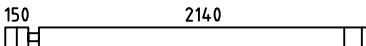
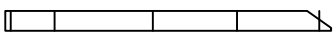
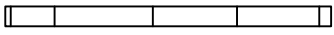
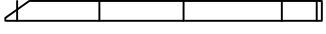
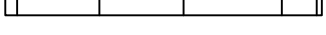
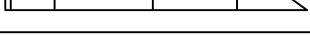
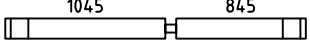
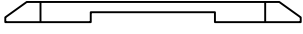
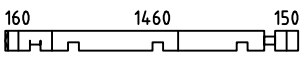
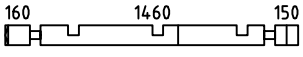
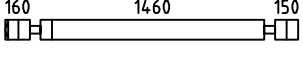
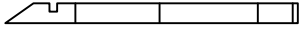
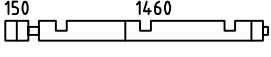
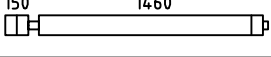
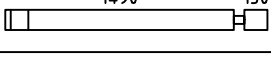
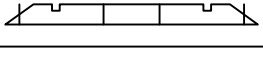
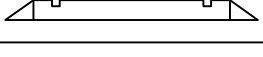
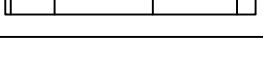
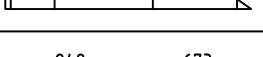
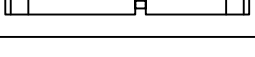
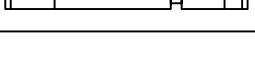
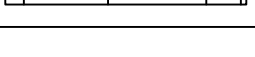
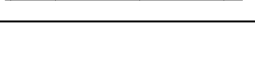
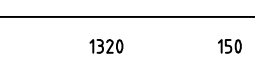



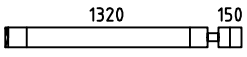
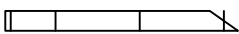
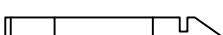
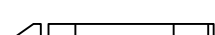

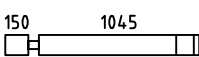
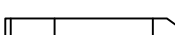
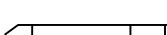
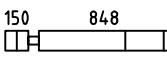
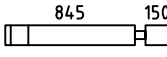
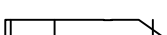

11/70/23

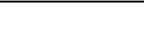
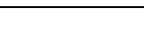
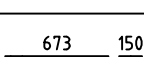
Pos	///70/23	ST	F (mm)	L (mm)
001		1	70x130	6300
002		1	70x130	6300
003		1	70x129	6300
004		1	70x130	6300
005		2	70x130	6300
006		1	70x130	6300
007		1	70x130	6043
008		1	70x130	6043
009		1	70x130	5677
010		1	70x130	5677
011		1	70x130	5390
012		1	70x130	5390
013		2	70x130	5240
014		2	70x130	5195
015		2	70x130	5020
016		2	70x130	4892
017		1	70x130	4892
018		1	70x130	4892
019		1	70x130	4780
020		1	70x130	4780
021		1	70x130	4780
022		1	70x130	4585
023		3	70x130	4585
024		1	70x130	4585
025		2	70x130	4578

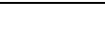



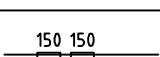





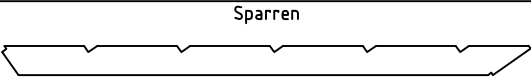





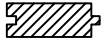

Pos	///70/23	ST	F (mm)	L (mm)
026		2	70x130	4410
027		1	70x130	4410
028		1	70x130	4410
029		6	70x130	3858
030		1	70x130	3858
031		7	70x130	3780
032		1	70x130	3740
033		3	70x130	3740
034		2	70x65	3545
035		6	70x130	3545
036		2	70x130	3545
037		1	70x130	3460
038		5	70x130	3370
039		1	70x130	3370
040		1	70x130	3345
041		1	70x130	3345
042		2	70x130	3250
043		1	70x130	3150
044		1	70x130	3150
045		1	70x130	3130
046		7	70x130	3130
047		2	70x130	3055
048		1	70x130	2975
049		1	70x130	2975
050		1	70x130	2950

Pos	///70/23	ST	F (mm)	L (mm)
051		3	70x130	2950
052		1	70x130	2950
053		1	70x130	2950
054		1	70x130	2890
055		16	70x130	2890
056		1	70x65	2890
057		1	70x130	2880
058		1	70x130	2880
059		1	70x130	2840
060		1	70x130	2830
061		1	70x130	2830
062		1	70x130	2770
063		1	70x130	2770
064		2	70x130	2755
065		2	70x65	2755
066		4	70x130	2755
067		2	70x130	2755
068		2	70x130	2730
069		1	70x130	2702
070		15	70x130	2670
071		1	70x130	2642
072		3	70x130	2580
073		1	70x130	2580
074		1	70x130	2518
075		1	70x130	2458

Pos		ST	F (mm)	L (mm)
076		8	70x130	2360
077		1	70x130	2126
078		1	70x130	2126
079		1	70x130	2066
080		1	70x130	2066
081		1	70x130	1969
082		7	70x130	1960
083		2	70x130	1927
084		1	70x130	1910
085		1	70x130	1910
086		2	70x130	1910
087		1	70x130	1909
088		1	70x130	1715
089		4	70x130	1715
090		7	70x130	1710
091		2	70x130	1648
092		1	70x130	1648
093		1	70x130	1632
094		1	70x130	1603
095		8	70x130	1590
096		15	70x130	1580
097		1	70x130	1572
098		4	70x130	1547
099		1	70x130	1543
100		2	70x130	1540

Pos		ST	F (mm)	L (mm)
101		1	70x130	1540
102		4	70x130	1518
103		1	70x130	1420
104		1	70x130	1360
105		4	70x130	1335
106		7	70x130	1265
107		1	70x130	1137
108		1	70x130	1077
109		8	70x130	1068
110		7	70x130	1065
111		1	70x130	1053
112		4	70x130	1052
113		1	70x130	993
114		4	70x130	968
115		3	70x130	938
116		3	70x130	916
117		15	70x130	893
118		1	70x130	643
119		1	70x130	643
120		1	70x130	583
121		1	70x130	583
122		4	70x130	558
123		15	70x130	450
124		1	70x130	370
125		16	70x130	370

Pos		ST	F (mm)	L (mm)	
LT3		Vt. joonist!	1	90x140	3680
LT6		Vt. joonist!	1	90x140	3680
LT1			6	90x140	3680
LT2			8	90x140	2890
LT5			1	90x140	2840
LT4		Vt. joonist!	1	90x140	2578
LT7		Vt. joonist!	1	90x140	1376
AR5		Fundamentbalken impr.	4	68x94	5990
AR1		Fundamentbalken impr.	1	68x94	4788
AR3		Fundamentbalken impr.	3	68x94	3288
AR4		Fundamentbalken impr.	3	68x94	2498
AR8		Fundamentbalken impr.	2	68x94	2035
AR11		Fundamentbalken impr.	1	68x94	1967
AR2		Fundamentbalken impr.	3	68x94	1432
AR6		Fundamentbalken impr.	5	44x94	4328
AR10		Fundamentbalken impr.	22	44x94	2893
AR9		Fundamentbalken impr.	11	44x94	1967
AR7		Fundamentbalken impr.	5	44x94	1458
PR1			5	70x190	5380
PR3			1	70x190	5380
PR5			5	70x190	5380
PR6			5	70x190	3240
PR2			5	70x190	3240
PR4			1	70x190	3240

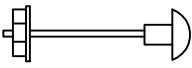
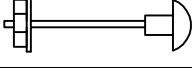
Pos			ST	F (mm)	L (mm)
SA1		Vt.joonist!	2	70x190	3463
135	Fussbodenbretter		66	90x26	3286
136	Fussbodenbretter		66	90x26	2496
137	Terrassenbretter	impr. 	22	90x26	4930
138	Terrassenbretter	impr. 	64	90x26	1500
139	Schlafbodenbretter		7	90x26	3246
			7	90x26	1286
			29	90x26	1948
			29	90x26	3908
			29	90x26	3418
			29	90x26	2438
140	Dachbretter		184	90x20	4100
141	Innedachbretter		132	90x20	3575
142	Abdeckleiste			20x40	200lfm
143	Träger für Innedachbretter		4	50x50	3288
144	Träger für Innedachbretter		4	50x50	2498
G1	Gewindestift 12		6		2620
G2	Gewindestift 12		2		540
G3	Gewindestift 12		7		410
145	Bolzen für Dachbalken		44	M12	80
146	Bolzen für Deckenbalken		32	M12	100

